

FAGOR 8055 CNC

Ordering Handbook.
Ref. 1406



CNC FAGOR 8055

FAGOR 
FAGOR AUTOMATION

DENOMINATIONS

UC55 □ - □ - □ - □ - □ - □ - □ - □ - □ - □ - □ - □

Type of CNC (CNC 8055 Central Unit)			MDU Dual-use products (3)		
CPU type	FL Power	F W	Advanced software - Standard software AV Advanced software		
Type of function			Software options (2)		
General purpose (1)		GP	A	Remote hard disk	
Milling machines & Centers (1)		M	B	Ethernet	
Conversational model for Milling (1)		MC	E	Rigid tapping	
Open conversational for Milling (1)		MCO	G	Tool life monitoring	
Lathes and Turning Centers		T	H	Probing canned cycles	
Conversational model for Lathes		TC	J	4-axis interpolation	
Open conversational for Lathes (1)		TCO	K	Telediagnosis	
Chassis (power supply included)			Q	C axis on lathe	
For 3 modules (PSB3)		3	S	Tool radius compensation	
For 6 modules (PSB6)		6	T	Y axis on lathe	
Axis module			U	TCP option	
Complete		A	V	Tangential control	
Single		SA	X	Retracing	
I/O module			Axes		
None		-	2	Lathe	
1 I/O module		1I	4	Mill and lathe	
2 I/O modules		2I	7	Mill and Lathe (Power models)	
3 I/O modules		3I	KEYCF board		
4 I/O modules		4I	B	Basic (512 MB)	
Digital servo drives			L	Large (2 GB)	
None (analog only)		-	Field bus for remote modules		
Sercos board		SB	-	Not available	
CAN servos board		CD			

(1) Not available with FL model
 (2) Depends on the CPU type and function
 (3) Products manufactured by FAGOR AUTOMATION since April 1st 2014 will include "-MDU" in their identification if they are included on the list of dual-use products according to regulation UE 428/2009 and require an export license depending on destination.

CONFIGURATIONS

Central Unit + (Monitor + Keyboard + Operator Panel)



Central Unit + (Monitor + Keyboard + Operator Panel)

83480204	MONITOR-55M-11-USB	For Milling machines & Centers
83480205	MONITOR-55MC-11-USB	Conversational model for Milling
83480206	MONITOR-55T-11-USB	For Lathes & Turning Centers
83480207	MONITOR-55TC-11-USB	Conversational model for Lathes

Central Unit + (Monitor) + (Keyboard + Operator Panel)

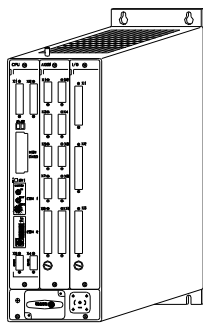

Central Unit



Monitor

83480115 MONITOR-8055

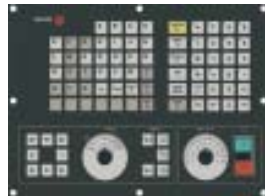

(Keyboard + Operator Panel)

83540044 OP-8055-ALFA

For Milling machines, Centers,
Lathes & Turning Centers

83540045 OP-8055-MC

Conversational model for Milling

83540046 OP-8055-TC

Conversational model for Lathes

83540047 OP-8055MCO/TCO

Customizable

MAKING UP THE CENTRAL UNIT

Power Supply and Box

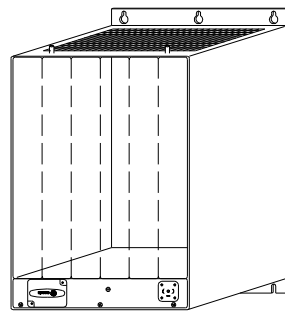
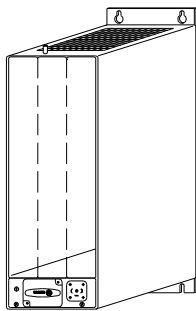

83060100 PSB3-8055

For three modules

83060101 PSB6-8055

For six modules

CPU module

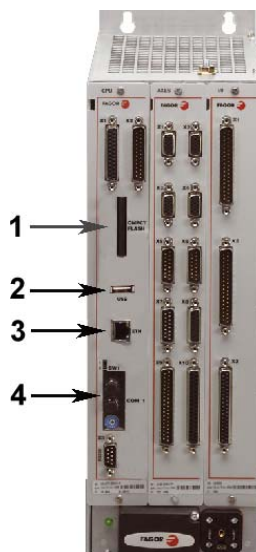

83090514 CPU-8055 FL-T

For Lathes & Turning Centers

83090520 CPU-8055 Power-GP

Fpr General Propourse

83090513 CPU-8055 Power-M

For Milling machines & Centers

83090515 CPU-8055 Power-T

For Lathes & Turning Centers

1.- KEYCF

Compact Flash memory to store: OEM programs, PLC program, screen customizing programs, tables, parameters, etc

The basic KEYCF has 512 Mb

Optional 2 GB KEYCF:

83240131 KEY CF 8055 FL LARGE

83240133 KEY CF 8055 Power LARGE

2.- USB

3.- Ethernet connexion (Require software option)

4.- Digital interface option

83160110 SER-INT-BOARD

83160135 CAN-AXES-BOARD-8055

AXES module

It must be present in all the configurations

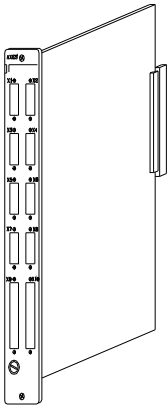

83150110 AXES 8055 VPP with 8 analog outputs and 8 feedback inputs.

Module to process the signals to control the axes, the spindle and the handwheels.

- 8 analog outputs and 8 feedback inputs.
- Probe input and 8 analog inputs.
- 40 PLC opto-coupled digital inputs
- 24 PLC opto-coupled digital outputs (24 Vdc)

83240203 AXES 8055 VPP SB with 8 analog outputs and 8 feedback inputs.

Module to process the signals to control the axes, the spindle and the handwheels.

- 4 analog outputs and 4 feedback inputs.
- Probe input and 8 analog inputs.
- 40 PLC opto-coupled digital inputs
- 24 PLC opto-coupled digital outputs (24 Vdc)

Additional modules

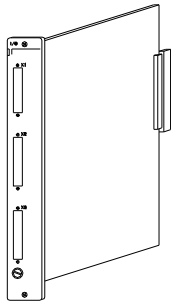

I/O Module

83210100 I/O 8055

Digital I/O expansion module

- 64 PLC opto-coupled digital inputs
- 32 PLC opto-coupled digital outputs (24 Vdc)



Front Cover

83300100 COVER 8055

The front of the box must be completed with front covers.

CABLES

Central Unit + (Monitor + Keyboard + Operator Panel)

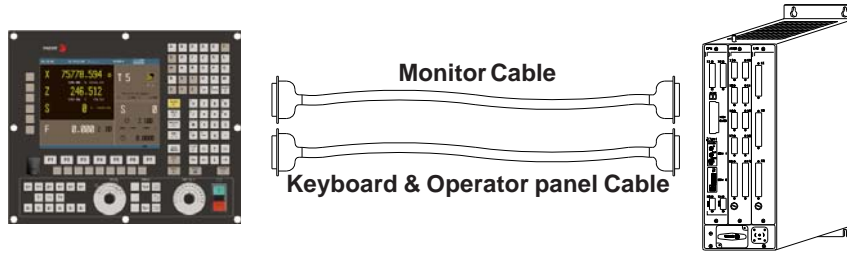

Central Unit + (Monitor) + (Keyboard + Operator Panel)

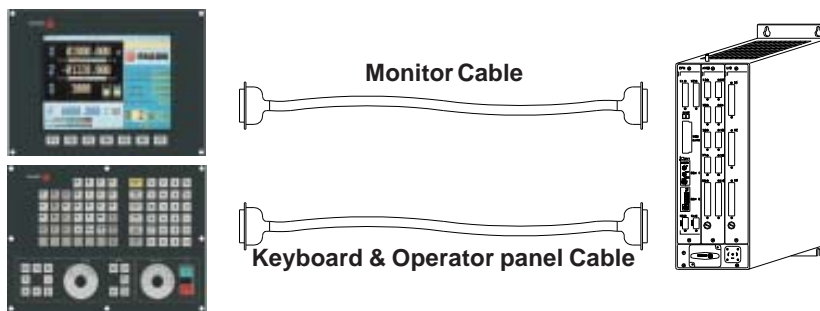

Monitor cables

2m	C.MON.50/55-2M	03630019
5m	C.MON50/55 5M	03630020
10m	C.MON50/55 10M	03630021
15m	C.MON50/55 15M	03630022
20m	C.MON50/55 20M	03630023
25m	C.MON50/55 25M	03630024
30m	CABLE MON.30M	03630025
35m	CABLE MON.35M	03630026
40m	CABLE MON.40M	03630027

Keyboard & Operator panel cables

2m	JOG CABLE-2M	03630002
5m	JOG CABLE-5M	03630004
10m	JOG CABLE-10M	03630005
15m	JOG CABLE-15M	03630006
20m	JOG CABLE-20M	03630008
25m	JOG CABLE-25M	03630009
30m	C.JOG 30M	03630045
35m	C.JOG 35M	03630046
40m	C.JOG 40M	03630047
45m	C.JOG 45M	03630048
50m	C.JOG 50M	03630049

SERCOS cables

Sercos optic fiber

1m	SFO-1	03900001
2m	SFO-2	03900002
3m	SFO-3	03900003
5m	SFO-5	03900005
7m	SFO-7	03900007
10m	SFO-10	03900010
12m	SFO-12	03900012

Flexible Sercos optic fiber

10m	SFO-FLEX-10	03910010
15m	SFO-FLEX-15	03910015
20m	SFO-FLEX-20	03911030
25m	SFO-FLEX-25	03911035
30m	SFO-FLEX-30	03910030
35m	SFO-FLEX-35	03910035
40m	SFO-FLEX-40	03910040
40m	SFO-V-FLEX-40	03920040
50m	SFO-V-FLEX-50	03920050
60m	SFO-V-FLEX-60	03920060
75m	SFO-V-FLEX-75	03920075
100m	SFO-V-FLEX-100	03920100

KEYCF AND SOFTWARE FEATURES.

The KEYCF include the software features by means of a special code.

It must be used to store critical data used for customizing the CNC for that machine, parameters, PLC programs and screens.

The remaining memory space is free for storing User programs.

Basic 512 MB KEYCF

For 8055i FL model **KEY CF 8055 FL BASIC** **83240130**
 For 8055i Power model **KEY CF 8055 Power BASIC** **83240132**

Opcional 2GB KEYCF

For 8055i FL model **KEY CF 8055 FL LARGE** **83240131**
 For 8055i Power model **KEY CF 8055 Power LARGE** **83240133**

Software options for CNC 8055 FL model

Code	Software features	T	TC
	Block processing time	3.5 ms	
	Loop time	4 ms	
	Look ahead	100 blocks	
80501010	Number of axes with standard software	(2)	(2)
80501000	Number of axes with optional software	(4)	(4)
	Save, Edit & Execute programs in KEYCF	(1)	(1)
	Electronic threading	(1)	(1)
	Tool magazine management	(1)	(1)
	Machining canned cycle	(1)	(1)
83240166	Remote Hard disk	()	()
83240167	Ethernet	()	()
80501004	Rigid tapping	()	()
80501006	Tool life monitoring	()	()
80501007	Probing canned cycles	()	()
83240501	Telediagnosis	()	()
83270003	Tool radius compensation	(1)	(1)
83240145	Tangential Control	()	()
83240155	Retracing	()	()
83240148	T Basic Software	(1)	(1)
83240142	TC Conversational Software	(-)	(1)
80501002	Line and Solid graphics	(1)	(1)
80501008	DNC Communications	(1)	(1)
83270002	Profile editor	(1)	(1)
83240156	Setup assistance	(1)	(1)

- (-) Not available
- () Optional feature
- (1) Standard feature

Software options for CNC 8055 Power model

Code	Software features	GP	M	MC	MCO	T	TC	TCO
	Block processing time	1 ms						
	Loop time	2 ms						
	Look ahead	200 blocks						
80501010	Number of axes with standard software	(4)	(4)	(4)	(4)	(2)	(2)	(2)
80501000	Number of axes with optional software	(7)	(7)	(7)	(7)	(4)	(4)	(4)
80501001	Number of axes with optional software	(-)	(-)	(-)	(-)	(7)	(7)	(7)
	Save, Edit & Execute programs in KEYCF	(1)	(1)	(1)	(1)	(1)	(1)	(1)
	Electronic threading	(-)	(1)	(1)	(1)	(1)	(1)	(1)
	Tool magazine management	(-)	(1)	(1)	(1)	(1)	(1)	(1)
	Machining canned cycle	(-)	(1)	(1)	(-)	(1)	(1)	(-)
	Multiple machining canned cycle	(-)	(1)	(1)	(-)	(-)	(-)	(-)
83240166	Remote Hard disk	(-)	(-)	(-)	(-)	(-)	(-)	(-)
83240167	Ethernet	(-)	(-)	(-)	(-)	(-)	(-)	(-)
80501004	Rigid tapping	(-)	(-)	(-)	(-)	(-)	(-)	(-)
80501006	Tool life monitoring	(-)	(-)	(-)	(-)	(-)	(-)	(-)
80501007	Probing canned cycles	(-)	(-)	(-)	(-)	(-)	(-)	(-)
80501009	4-axis interpolation	(-)	(-)	(-)	(-)	(-)	(-)	(-)
83240501	Telediagnosis	(-)	(-)	(-)	(-)	(-)	(-)	(-)
83270001	C Axis for Lathe	(-)	(-)	(-)	(-)	(-)	(-)	(-)
83270003	Tool radius compensation	(-)	(1)	(1)	(1)	(1)	(1)	(1)
83270009	Y Axis for Lathe	(-)	(-)	(-)	(-)	(-)	(-)	(-)
83240500	Opción TCP // TCP Option	(-)	(-)	(-)	(-)	(-)	(-)	(-)
83240145	Tangential Control	(-)	(-)	(-)	(-)	(-)	(-)	(-)
83240155	Retracing	(-)	(-)	(-)	(-)	(-)	(-)	(-)
83240220	GP Basic Software	(1)	(-)	(-)	(-)	(-)	(-)	(-)
83240149	M Basic Software	(-)	(1)	(1)	(1)	(-)	(-)	(-)
83240141	MC Conversational Software	(-)	(-)	(1)	(-)	(-)	(-)	(-)
83240143	MCO Conversational Software	(-)	(-)	(-)	(1)	(-)	(-)	(-)
83240148	T Basic Software	(-)	(-)	(-)	(-)	(1)	(1)	(1)
83240142	TC Conversational Software	(-)	(-)	(-)	(-)	(-)	(1)	(-)
83240144	TCO Conversational Software	(-)	(-)	(-)	(-)	(-)	(-)	(1)
80501002	Line and Solid graphics	(-)	(1)	(1)	(1)	(1)	(1)	(1)
80501003	Pockets with islands	(-)	(1)	(1)	(1)	(-)	(-)	(-)
80501008	DNC Communications	(1)	(1)	(1)	(1)	(1)	(1)	(1)
83270002	Profile editor	(1)	(1)	(1)	(1)	(1)	(1)	(1)
83240156	Setup assistance	(1)	(1)	(1)	(1)	(1)	(1)	(1)

(-) Not available

(1) Standard feature

() Optional feature

IN ORDER TO COMPLETE ITS ORDER

Monitor + Keyboard + Operator panel			
	83480204	MONITOR-55M-11-USB	
	83480205	MONITOR-55MC-11-USB	
	83480206	MONITOR-55T-11-USB	
	83480207	MONITOR-55TC-11-USB	

SEPARATE: Monitor		Keyboard + Operator panel	
	83480115	MONITOR-8055	
	83540044	OP-8055-ALFA	
	83540045	OP-8055-MC	
	83540046	OP-8055-TC	
	83540047	OP-8055-MCO/TCO	

Power Supply and Box			
	83060100	PSB3-8055	For three modules
	83060101	PSB6-8055	For six modules

CPU module			
	83090514	CPU-8055 FL-T	
	83090520	CPU-8055 Power-GP	
	83090513	CPU-8055 Power-M	
	83090515	CPU-8055 Power-T	
Digital interface option			
	83160110	SER-INT-BOARD	
	83160135	CAN-AXES-BOARD-8055	

Modules			
	83150110	AXES 8055 VPP	
	83240203	AXES 8055 VPP SB	
	83210100	I/O 8055	
	83300100	COVER 8055	

KEYCF			
	83240130	KEY CF 8055 FL BASIC	
	83240132	KEY CF 8055 Power BASIC	
	83240131	KEY CF 8055 FL LARGE	
	83240133	KEY CF 8055 Power LARGE	

SOFTWARE FEATURES			
	80501010	4 axes for Milling / 2 axes for Lathe	
	80501000	7 axes for Milling / 4 axes for Lathe	7 axes only for CNC 8055 Power
	80501001	7 axes for Lathe	Only for CNC 8055 Power
	83240166	Remote Hard disk	
	83240167	Ethernet	
	80501004	Rigid tapping	
	80501006	Tool life monitoring	No available for GP model
	80501007	Probing canned cycles	No available for GP model
	80501009	4-axis interpolation limit	Only for CNC 8055 Power
	83240501	Telediagnosis	
	83270001	C Axis for Lathe	Only for CNC 8055 Power
	83270003	Tool radius compensation	
	83270009	Y Axis for Lathe	Only for CNC 8055 Power
	83240500	TCP Option for Milling	Only for CNC 8055 Power
	83240145	Tangential Control	
	83240155	Retracing	
	83240220	GP Basic Software	
	83240149	M Basic Software	
	83240141	MC Conversational Software	
	83240143	MCO Conversational Software	
	83240148	T Basic Software	
	83240142	TC Conversational Software	
	83240144	TCO Conversational Software	

Manuals

03M50000	M.CNC 8055 M OEM-CAS	8055 M CNC OEM Manual in Spanish
03M50001	M.CNC 8055 M OEM-ING	8055 M CNC OEM Manual in English
03M50004	M.CNC 8055 M OEM-ITA	8055 M CNC OEM Manual in Italian
03M50010	M.CNC 8055 M USER-CAS	8055 M CNC user Manual in Spanish
03M50011	M.CNC 8055 M USER-ING	8055 M CNC user Manual in English
03M50012	M.CNC 8055 M USER-FRA	8055 M CNC user Manual in French
03M50013	M.CNC 8055 M USER-ALE	8055 M CNC user Manual in German
03M50014	M.CNC 8055 M USER-ITA	8055 M CNC user Manual in Italian
03M50015	M.CNC 8055 M USER-BRA	8055 M CNC user Manual in Portuguese-Brazilian
03M50016	M.CNC 8055 M USER-HOL	8055 M CNC user Manual in Dutch
03M50020	M.CNC 8055 T OEM-CAS	8055 T CNC OEM Manual in Spanish
03M50021	M.CNC 8055 T OEM-ING	8055 T CNC OEM Manual in English
03M50024	M.CNC 8055 T OEM-ITA	8055 T CNC OEM Manual in Italian
03M50030	M.CNC 8055 T USER-CAS	8055 T CNC user Manual in Spanish
03M50031	M.CNC 8055 T USER-ING	8055 T CNC user Manual in English
03M50032	M.CNC 8055 T USER-FRA	8055 T CNC user Manual in French
03M50033	M.CNC 8055 T USER-ALE	8055 T CNC user Manual in German
03M50034	M.CNC 8055 T USER-ITA	8055 T CNC user Manual in Italian
03M50035	M.CNC 8055 T USER-BRA	8055 T CNC user Manual in Portuguese-Brazilian
03M50036	M.CNC 8055 T USER-HOL	8055 T CNC user Manual in Dutch
03M50040	M.CNC 8055 MC USER-CAS	8055 MC CNC user Manual in Spanish
03M50041	M.CNC 8055 MC USER-ING	8055 MC CNC user Manual in English
03M50042	M.CNC 8055 MC USER-FRA	8055 MC CNC user Manual in French
03M50043	M.CNC 8055 MC USER-ALE	8055 MC CNC user Manual in German
03M50044	M.CNC 8055 MC USER-ITA	8055 MC CNC user Manual in Italian
03M50045	M.CNC 8055 MC USER-BRA	8055 MC CNC user Manual in Portuguese-Brazilian
03M50046	M.CNC 8055 MC USER-HOL	8055 MC CNC user Manual in Dutch
03M50050	M.CNC 8055 TC USER-CAS	8055 TC CNC user Manual in Spanish
03M50051	M.CNC 8055 TC USER-ING	8055 TC CNC user Manual in English
03M50052	M.CNC 8055 TC USER-FRA	8055 TC CNC user Manual in French
03M50053	M.CNC 8055 TC USER-ALE	8055 TC CNC user Manual in German
03M50054	M.CNC 8055 TC USER-ITA	8055 TC CNC user Manual in Italian
03M50055	M.CNC 8055 TC USER-BRA	8055 TC CNC user Manual in Portuguese-Brazilian
03M50056	M.CNC 8055 TC USER-HOL	8055 TC CNC user Manual in Dutch
03M50060	M.CNC 8055 MCO/TCO USER-CAS	8055 MCO/TCO CNC user Manual in Spanish
03M50061	M.CNC 8055 MCO/TCO USER-ING	8055 MCO/TCO CNC user Manual in English
03M50062	M.CNC 8055 MCO/TCO USER-FRA	8055 MCO/TCO CNC user Manual in Spanish
03M50063	M.CNC 8055 MCO/TCO USER-ALE	8055 MCO/TCO CNC user Manual in Spanish
03M50064	M.CNC 8055 MCO/TCO USER-ITA	8055 MCO/TCO CNC user Manual in Italian
03M50065	M.CNC 8055 MCO/TCO USER-BRA	8055 MCO/TCO CNC user Manual in Spanish
03M50066	M.CNC 8055 MCO/TCO USER-HOL	8055 MCO/TCO CNC user Manual in Spanish

Spare parts

83060110	PSB3-8055(R)	83160115	SERCOS-INT-BOARD(R)
83060111	PSB6-8055(R)	83160145	CAN-AXES-BOARD-8055 (RF)
83090516	CPU-8055 FL (R)	83150105	AXES 8055 VPP (R)
83090517	CPU-8055 Power (R)	83240204	AXES 8055 VPP SB (R)
80550045	I/O 8055(R)	83300101	COVER 8055(R)

Monitor cables

03630019	C.MON.50/55-2M	03630024	C.MON50/55 25M
03630020	C.MON50/55 5M	03630025	CABLE MON.30M
03630021	C.MON50/55 10M	03630026	CABLE MON.35M
03630022	C.MON50/55 15M	03630027	CABLE MON.40M
03630023	C.MON50/55 20M		

Keyboard & Operator panel cables

03630002	JOG CABLE-2M
03630004	JOG CABLE-5M
03630005	JOG CABLE-10M
03630006	JOG CABLE-15M
03630008	JOG CABLE-20M
03630009	JOG CABLE-25M

03630045	C.JOG 30M
03630046	C.JOG 35M
03630047	C.JOG 40M
03630048	C.JOG 45M
03630049	C.JOG 50M

Sercos optic fiber cables

03900001	SFO-1
03900002	SFO-2
03900003	SFO-3
03900005	SFO-5

03900007	SFO-7
03900010	SFO-10
03900012	SFO-12

Flexible Sercos optic fiber cables

03910010	SFO-FLEX-10
03910015	SFO-FLEX-15
03910020	SFO-FLEX-20
03910025	SFO-FLEX-25
03910030	SFO-FLEX-30
03910035	SFO-FLEX-35
03910040	SFO-FLEX-40

03920040	SFO-V-FLEX-40
03920050	SFO-V-FLEX-50
03920060	SFO-V-FLEX-60
03920075	SFO-V-FLEX-75
03920100	SFO-V-FLEX-100